

# TECHNICAL DATA SHEET

V1.0



## FIBERON™ PET-CF17

Fiberon™ PET-CF17 is a carbon fiber reinforced PET (polyethylene terephthalate) filament. It's the preferred choice for engineering 3D printing composite materials, featuring high modulus, heat resistance, moisture insensitivity, and ease of printing.

[WWW.FIBERON3D.COM](http://WWW.FIBERON3D.COM)

### PHYSICAL PROPERTIES

PROPERTY	TESTING METHOD	TYPICAL VALUE
Density	ISO1183, GB/T1033	1.34 g/cm <sup>3</sup> at 23°C
Melt index	270°C, 2.16 kg	30.7 g/10min
Flame retardancy	UL 94, 1.5mm	HB
Surface Resistivity (Ω)	ANSI ESD S11.11	OL, >10 <sup>12</sup> Ω

### MOISTURE ABSORPTION CURVE

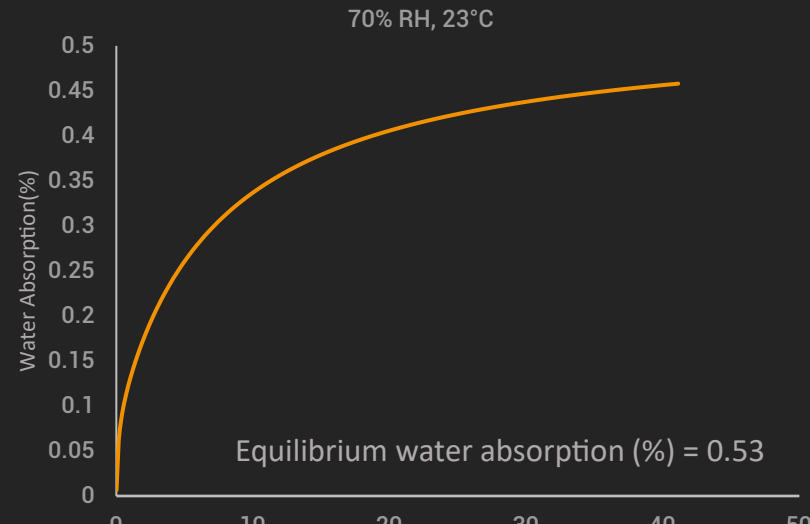

### HDT CURVE

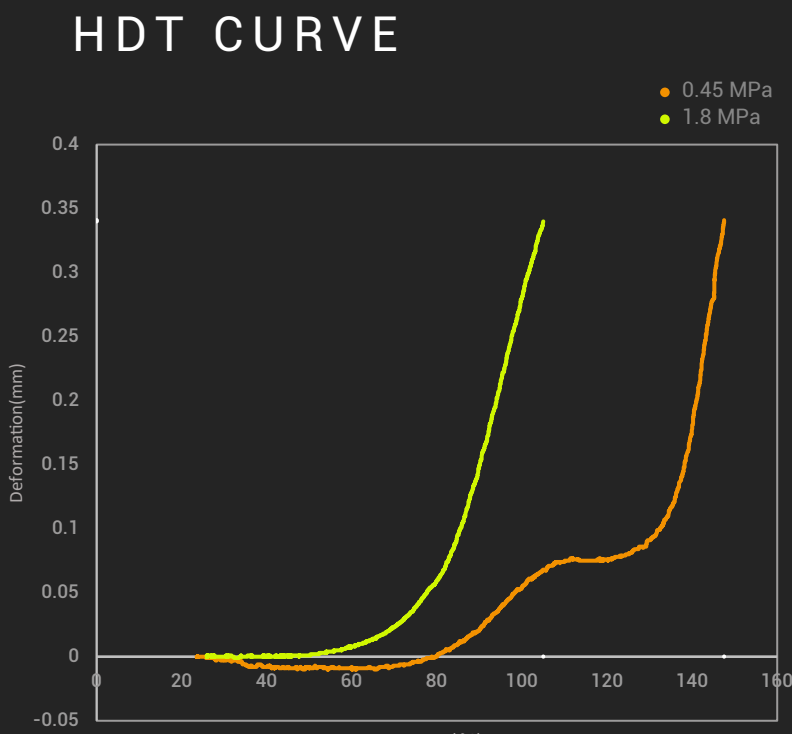

### THERMAL PROPERTIES

PROPERTY	TESTING METHOD	TYPICAL VALUE
Glass transition temp.	DSC, 10°C/min	79.3 °C
Melting temperature	DSC, 10°C/min	241.3 °C
Crystallization temp.	DSC, 10°C/min	202.9 °C
Decomposition temp.	TGA, 20°C/min	434.0 °C
Vicat softening temp.	ISO 306, GB/T 1633	238.4 °C
Heat deflection temp.	ISO 75 1.8MPa	105 °C
Heat deflection temp.	ISO 75 0.45MPa	147.5 °C

### MECHANICAL PROPERTIES

PROPERTY	TESTING METHOD	TYPICAL VALUE
Young's modulus (X-Y)	ISO 527, GB/T 1040	5481.0 ± 223.7 MPa
Young's modulus (Z)		3558.8 ± 260.4 MPa
Tensile strength (X-Y)	ISO 527, GB/T 1040	65.9 ± 1.0 MPa
Tensile strength (Z)		27.9 ± 1.3 MPa
Elongation at break (X-Y)	ISO 527, GB/T 1040	2.4 ± 0.5%
Elongation at break (Z)		0.8 ± 0.1%
Bending modulus (X-Y)	ISO 178, GB/T 9341	4744.4 ± 136.3 MPa
Bending modulus (Z)		2768.2 ± 422.6 MPa
Bending strength (X-Y)	ISO 306, GB/T 1633	109.3 ± 2.0 MPa
Bending strength (Z)		43.4 ± 8.8 MPa
Charpy impact strength (X-Y) notched	ISO 179, GB/T 1043	5.1 ± 0.2 kJ/m <sup>2</sup>
Charpy impact strength (X-Y) un-notched		25.1 ± 2.8 kJ/m <sup>2</sup>
Charpy impact strength (Z) un-notched		3.1 ± 0.7 kJ/m <sup>2</sup>

\*All specimens were annealed at 120°C for 10h.

### SHRINKAGE TESTING

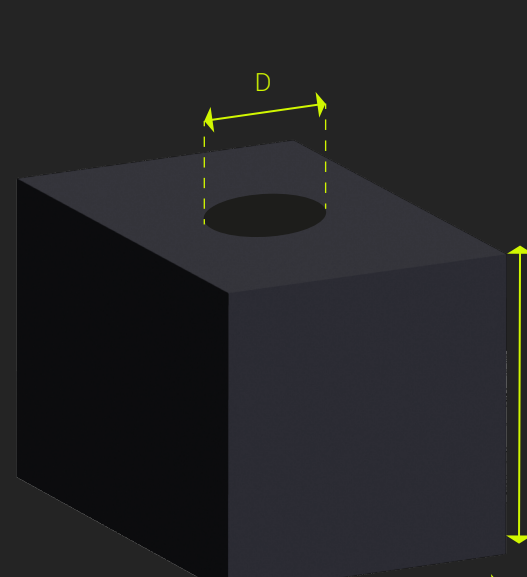

	MODEL SIZE	AFTER PRINTING	AFTER ANNEALING
X-Y	40mm	39.94mm	39.40mm
Z	40mm	40.25mm	40.33mm
Diameter	10mm	9.80mm	9.60mm

\*Model infill 30%

### RECOMMENDED PRINTING CONDITIONS

Nozzle temperature	270-300 °C
Build plate temperature	70-80 °C
Chamber temperature	Room temp.
Cooling fan	OFF

Printing speed	Up to 300mm/s
Drying temp. and time	100 °C/10H
Annealing temp. and time	120 °C/10H



PolySupport™ for PA12  
Recommended support material

### NOTE

We strongly recommend 120°C, 10h annealing to achieve the best performance of the material. To avoid deformation of the prints during annealing, please pay attention to the following:

- Before returning the prints, please confirm that the prints have been printed for more than 24h, or placed in an 80-degree oven for 2h to eliminate the internal stress after printing.
- During annealing, do not touch the sample with your hands or apply any additional load to the sample.
- During annealing, ensure that the temperature in the oven is uniform and there are no obvious obstructions that cause uneven temperature of the sample.
- For prints with a bridge length of more than 3cm, or a thick layer on the upper part of the bridge; prints with large overhangs or small overhangs; all need to add supports and anneal in the oven together with the supports.
- For thin-walled areas with a wall thickness of less than 4mm, you can try to add reinforcing ribs or increase the wall thickness to avoid possible annealing deformation.
- In principle, the sample placement method needs to be consistent with that during printing, and it is best to enter the oven directly together with the base plate.

### HOW TO MAKE SPECIMENS

Printing temperature	300 °C
Bed temperature	70 °C
Top & bottom layer	3

Infill	100%
Shell	2
Cooling fan	OFF

#### FLEXURAL TESTING SPECIMEN

ASTM D638 (ISO 527, GB/T 1040)

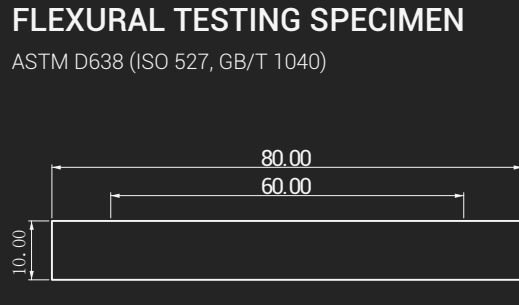

#### TENSILE TESTING SPECIMEN

ASTM D638 (ISO 527, GB/T 1040)

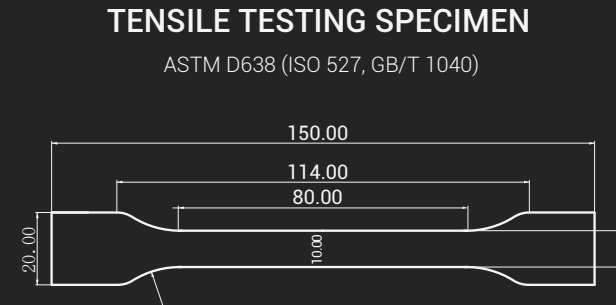

#### IMPACT TESTING SPECIMEN

ASTM D638 (ISO 179, GB/T 1043)

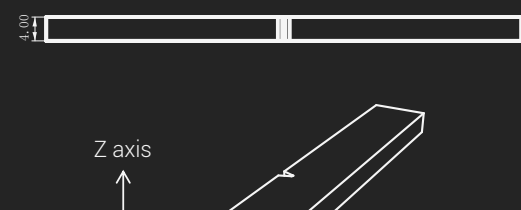
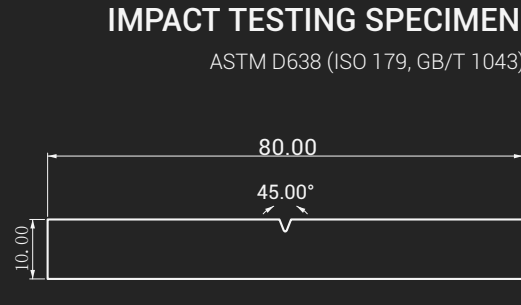

### DISCLAIMER

The typical values presented in this data sheet are intended for reference and comparison purposes only. They should not be used for design specifications or quality control purposes. Actual values may vary significantly with printing conditions. End-use performance of printed parts depends not only on materials, but also on part design, environmental conditions, printing conditions, etc. Product specifications are subject to change without notice. Each user is responsible for determining the safety, lawfulness, technical suitability, and disposal/recycling practices of Polymaker materials for the intended application. Polymaker makes no warranty of any kind, unless announced separately, to the fitness for any use or application. Polymaker shall not be made liable for any damage, injury or loss induced from the use of Polymaker materials in any application.

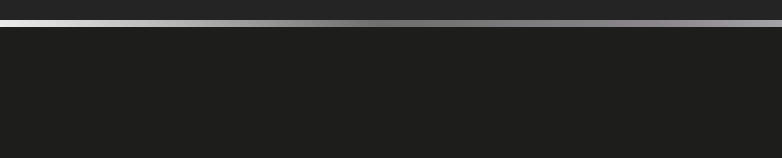

### MATERIALS COMPARISON

Heat resistance - Stiffness

